

Electronic Safe Lock SL 523 SL 525

Operating Manual

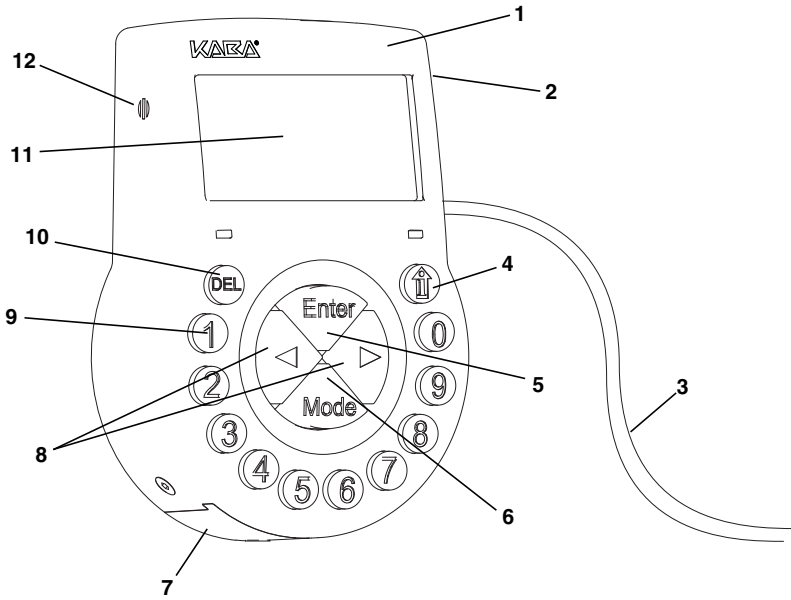

A1



A2

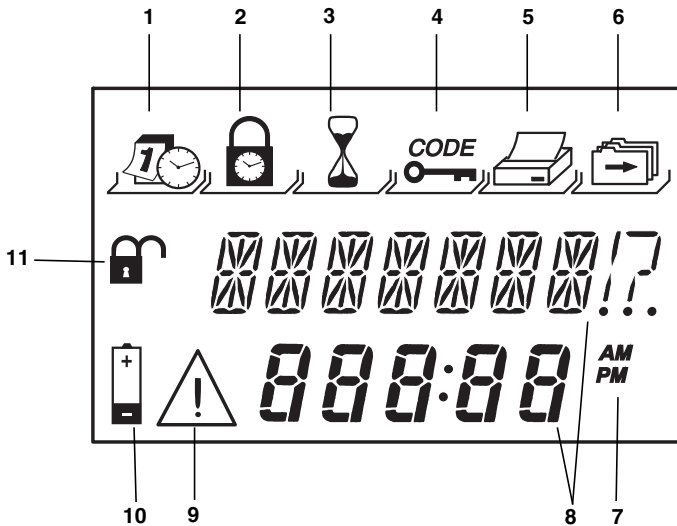

A3

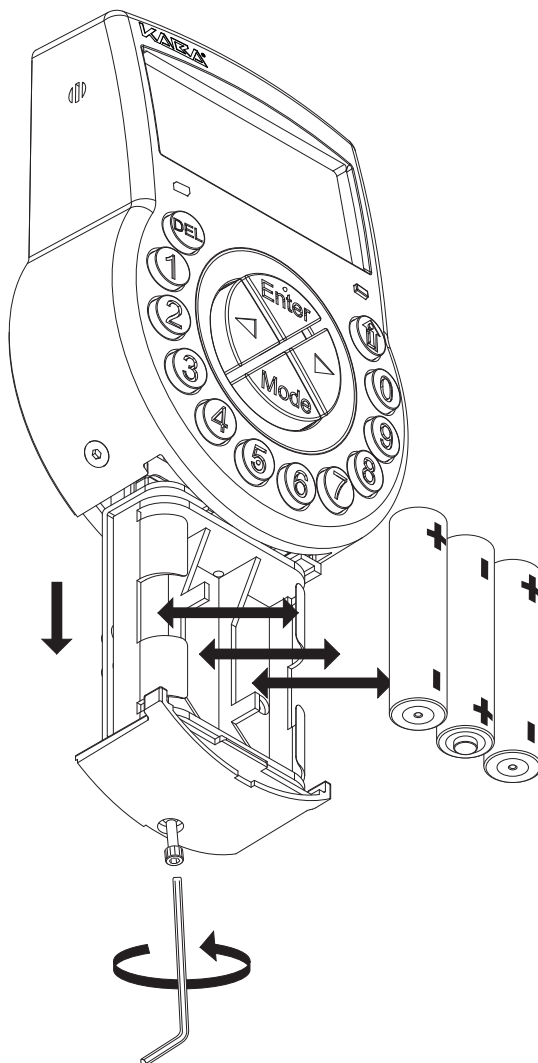

TABLE OF CONTENT

1	Product description	EN-3
1.1	Field of application	EN-3
1.2	Intended purpose	EN-3
1.3	Model types	EN-3
1.3.1	SL 523	EN-3
1.3.2	SL 525	EN-3
1.4	Conformity	EN-3
1.5	Technical data	EN-4
1.5.1	Functions	EN-4
1.5.2	Electronics	EN-4
1.5.3	Mechanics	EN-5
1.5.4	Approvals and Certificates	EN-5
1.5.5	Factory settings	EN-6
2	Information on this documentation	EN-7
2.1	Symbols and informatory notice	EN-7
2.1.1	Warning messages / notice / information	EN-7
2.1.2	Navigation aids	EN-7
2.1.3	Text markings	EN-7
3	Installation and Connection	EN-8
3.1	Preparations and checks	EN-8
3.2	Installation of Input Unit	EN-8
3.3	Installation of lock	EN-9
3.4	External connections	EN-10
3.5	Commissioning	EN-10
4	Operating and display devices / operating modes	EN-11
4.1	Operation and display elements	EN-11
4.1.1	Input Unit (illustration A1)	EN-11
4.1.2	Display (illustration A2)	EN-11
4.2	Buzzer signals	EN-11
4.3	Status messages	EN-12
4.3.1	Locked	EN-12
4.3.2	Open	EN-12
4.3.3	Time lock (Weekly)	EN-12
4.3.4	Time lock (Holiday)	EN-12
4.3.5	Time Delay	EN-12
4.3.6	Confirmation after elapse of Time Delay	EN-12
4.3.7	Dual Mode	EN-12
4.3.8	Penalty after wrong trials	EN-12
4.3.9	Remote Disabling	EN-12
4.3.10	Identification with denied code	EN-13
4.3.11	Audit Trail	EN-13
4.3.12	Connected with Programming Software	EN-13
4.3.13	The battery compartment has been opened!	EN-13
4.4	Operating modes	EN-13

4.4.1	Normal operation mode	EN-13
4.4.2	Programming mode	EN-13
4.4.3	Information menu	EN-13

5 Operation EN-14

5.1	Codes	EN-14
5.1.1	Code hierarchy and entry formats	EN-14
5.1.2	Code types	EN-15
5.1.3	Shelve Function	EN-15
5.1.4	Duress Code	EN-16
5.2	Code entry	EN-16
5.3	Opening procedure	EN-17
5.4	Closing procedure	EN-17

6 Programming EN-18

6.1	Menus and submenus	EN-18
6.2	Operating	EN-18
6.2.1	Activate Programming Mode	EN-18
6.2.2	Navigate in Programming Mode	EN-18
6.2.3	Change settings in Programming Mode	EN-18
6.2.4	Quit Programming Mode	EN-19
6.2.5	Exit	EN-19
6.3	Access rights	EN-19
6.4	Programming procedures	EN-20
6.4.1	Menu TIME (to set time/date)	EN-20
6.4.2	Menu PROG (to program Locking Periods)	EN-21
6.4.3	Menu DELAY (to program Time Delays)	EN-23
6.4.4	Menu CODE (to apply and modify codes)	EN-24
6.4.5	Menu AUDIT (to read-out event memory)	EN-26
6.4.6	Menu MISC (to access additional settings)	EN-26

7 Maintenance EN-29

7.1	Error messages	EN-29
7.2	Servicing	EN-30
7.2.1	Replacing batteries	EN-30
7.2.2	Cleaning	EN-30
7.3	Customer Service	EN-30
7.4	Spare parts and accessories	EN-31

INDEX EN-32

1 Product description

1.1 Field of application

The electronic safe locks SL 523 and SL 525 provide a wide range of functions for applications in the high security sector. They permit programming of various codes and code combinations, time related functions as well as storage and recall of a detailed event log (Audit Trail).

This electronic safe locks are especially suitable for applications where high security, multiple users, traceability and flexibility are required.

1.2 Intended purpose

The electronic safe locks SL 523 and SL 525 serve to block and release the mechanical blocking point of a safe, vault, data cabinet, ATM etc. which is usually activated manually by a boltwork. The electronic safe locks SL 523 and SL 525 can be employed instead of a mechanical combination or key lock. Applicable regulations and standards have to be observed.

Enabling (lock opening) is only performed upon entry of one or several codes on the Input Unit. The opening procedure can also be made dependent on time functions and/or external signals.

The electronic safe locks SL 523 and SL 525 may only be employed and operated in accordance with its intended use – blocking and releasing the mechanical blocking points of above mentioned equipment. Any other use is not recommended.

The electronic safe locks SL 523 and SL 525 are designed for indoor applications (environmentally protected areas) – they are not suitable for direct exposure to environmental impact.

1.3 Model types

Two models are available:

1.3.1 SL 523

The SL 523 is an intelligent motor-bolt lock with an integrated interface used for instance to connect to an alarm centre. It features a wide range of functionalities, such as a code hierarchy with User Group management, Courier Code, Dual Mode, Duress Code, Time Delay, Time Lock functions, Remote Disabling and a large audit with time/date reference. Operation and programming is done via input unit.

Electronic safe locks SL 523 are equipped with yellow navigation keys.

1.3.2 SL 525

Featuring the same wide basic range of functionalities as the SL 523, the SL 525 can in addition be programmed with Programming Software AS 254 (optionally available). This gives access to an even enhanced functionality and allows customer-tailored solutions to almost every extent.

Electronic safe locks SL 525 are equipped with blue navigation keys.

1.4 Conformity

Please find the Declaration of CE Conformity on page Z-1.

This product is compliant to the european guideline regarding the Restriction of Use of Hazardous Substances - RoHS 2002/95/EC.

This document is valid for input unit software version 90039.30 and newer, and lock software version 90048.30 and newer.

1.5 Technical data

1.5.1 Functions

Code functions	SL 523	SL 525
Code format	ID+PIN (2-digit ID + 6-digit PIN).	As with SL 523. Entry sequence can be reversed to PIN+ID (with Programming Software AS 254).
1 Master Code	8 digits (bearer: e.g. Safety Officer, Head of Security, Shop Owner). Can open alone in Dual Mode.	As with SL 523. Can be defined as „Master cannot open“ (with Programming Software AS 254).
2 Manager Codes	8 digits each (bearer: e.g. Head Cashier, Shift Manager).	
18 User Codes (in 2 groups of 9 each)	8 digits each, subordinated in groups to respective Manager Code (bearer: e.g. Cashier, Sales Assistant).	
1 Courier Code	8 digits, opening permission without opening delays (bearer: e.g. auditor, CIT (Cash In Transit service provider). Opens alone in Dual Mode.	
Code options	Duress Code: Can be performed by any code (if function is activated). Dual Mode: Two codes needed (Master Code and Courier Code can open alone). Code denial: Codes can be admitted/disabled to entire code groups.	
Time functions	SL 523	SL 525
Date / Time	Continuous calendar until 2099.	
Summer/winter time (Daylight Saving Time)	n/a	Algorithm (e.g. last Sunday in May), requires Programming Software AS 254.
Locking periods	16 Weekly Locking Periods, repeated weekly, each up to 7 days long. 22 Holiday Locking Periods, date-related, each up to 35 days long (can be defined as yearly repeatable).	
Immediate Time Lock	Locking with immediate action until next programmed Weekly Locking Period.	
Time Delays	Programmable from 0...99 minutes. 2 Time Delays, each programmable from 0...99 minutes. Time Delay 1: valid for Master, Manager 1 and User 11...19. Time Delay 2: valid for Manager 2 and User 21...29.	
Duress Time Delays	Equals Time Delays 1 and 2.	99 minutes (can be changed with Programming Software AS 254).
Confirmation Window	Programmable from 1...99 minutes.	
General	SL 523	SL 525
Locking	Automatically: After 6 seconds. Manually: Upon pressing DEL key. After closing of boltwork.	
Event memory	Min. 2400 events, protected against manipulation and power failure.	
Shelve Function	Master Code can delete, respectively reset all codes, functions and settings back to factory default values at once.	

1.5.2 Electronics

General	SL 523	SL 525
Power supply	3 Alkaline batteries 1.5 V LR6 (AA, AM3, E91), service life approx. 3-4 years (with 1 opening/closing cycle per working day, no load on lock bolt).	
Memory	Non-volatile (protected against power failure).	
Display	Iconographic LCD with high contrast. Display language user selectable (English, Dutch, French, German, Hungarian, Italian, Polish, Portuguese, Spanish).	
Keypad	Silicone keys (10 numeric, 4 function, 2 navigation keys).	

Interfaces	SL 523	SL 525
Outputs	2 potential free contacts for alarms (30VDC / 2A, 50VAC / 0.5A with resistive load). Output 1: Duress Alarm. Output 2: Bolt or motor open.	As with SL 523. Additional alarms programmable with Programming Software AS 254.
Inputs	Input 1 (signal-triggered 12VDC / 20mA): Remote Disabling. Input 2 (contact triggered): Time Delay Override.	Programmable with Programming Software AS 254: Input 1: Remote Disabling (standard setting) or Controlled Disabling. Input 2: Time Delay Override, or door position contact, or deactivated (standard setting). Input 3 (contact triggered): Duress by omission, or deactivated (standard setting).
Data interface	RS232 (9600 Baud, 8 Bit, 1 Stop-Bit, no parity) for Audit Trail read-out.	As with SL 523. Connection to Programming Software AS 254.

1.5.3 Mechanics

Lock	
Dimensions	85 x 61 x 33 mm
Weight	495 g
Mounting	3 screws M6 (template 67 x 41 mm)
Motor bolt	dead bolt (optional: spring bolt)
Relocker	integrated lock relocker
Cycle times	opening/closing approx. 2 seconds
Static resistance force	>1000 N in all directions
Moving force	max. 5 N both directions
Environmental conditions	operation: 0...+60°C / storage: -40...+70°C
Service life	>50 000 cycles
Input Unit	
Dimensions	128 (193) x 90 x 40 mm
Weight	660 g (including connection cable and batteries)
Environmental conditions	operation: 0...+60°C / storage: -40...+70°C / system of protection: IP53

1.5.4 Approvals and Certificates

Test marks	CE
Patent No.	US 6,434,987 B1; EP 1 069 264 B1
VdS (VdS 2396)	Electronic high-security lock class 2, approval only valid if marked on lock
VdS (VdS 2269 / VdS 2315)	Stroke plate contact for intruder alarm systems of class C
ECB-S (EN 1300)	Electronic high-security lock level B
Underwriter Laboratories (UL 2058)	High security electronic lock type 1 NOTE: the function "Duress" is not included in the scope of UL 2058 and is therefore declared as "not investigable by UL".
CNPP a2p	Level B/E
IMP	Class 2

1.5.5 Factory settings

Function	Factory setting		Can be changed with	
	523	525	Input Unit	AS 254 (opt.)
Display language *a)	English		✓	✓
Master Code	0 0 1 2 3 4 5 6, can open		✓	✓
Manager Code (max. 2)	not activated		✓	✓
User Code (max. 2 groups of 9)	not activated		✓	✓
Courier Code	not activated		✓	✓
Duress Code entry	not activated		✓	✓
Dual Mode	not activated		✓	✓
Number of wrong codes until penalty	4		–	–
Penalty upon wrong code entries	5 minutes		–	–
Time Delays	0 minutes (deactivated)		✓	✓
Duress Time Delays	equal to Time Delays	99 minutes	–	✓
Confirmation Window	5 minutes		✓	✓
Weekly Locking Period	not programmed		✓	✓
Holiday Locking Period / Repeated Holiday Locking Period	not programmed		✓	✓
Date / time	01.01.2002 0:00		✓	✓
Time format (12/24hrs.)	12 hrs. (AM/PM)		✓	✓
Summer/winter time (Daylight Saving Time)	n/a	not programmed	–	✓
Input 1 *b) (connections 5 and 6)	Remote Disabling		–	–
Input 2 *c) (connections 7 and 8)	Time Delay Override	not programmed	–	✓
Input 3 *c) (optional cable on lock socket Q2)	n/a	not programmed	–	✓
Output 1 *d) (connections 3 and 4)	Duress alarm		–	✓
Output 2 *d) (connections 1 and 2)	bolt or motor open		–	✓
Remote Disabling	not activated		✓	✓
Duress by Omission	n/a	not activated	–	✓
Code format	ID+PIN		–	✓
Buzzer volume	high		–	✓
Buzzer every 30 seconds while lock open	on		–	✓

Table 1: Factory settings

Remarks: *a) English, Dutch, French, German, Hungarian, Italian, Polish, Portuguese and Spanish can be selected.

*b) Input 1 is signal-triggered (12V / 13mA).

*c) Inputs 2 and 3 are contact-triggered.

*d) Relay contacts 1 and 2 are working contacts (NO, normally open) with default factory settings.

2 Information on this documentation

2.1 Symbols and informatory notice

2.1.1 Warning messages / notice / information

Depending on type of endangerment particular symbols, notice and designations will be used. They normally contain a message, a commentary and a description of how to avoid the current danger or how to continue.

Please take note of these notice to safely manipulate the system components and to immediately work with this documentation.



Warning!

Indicates a hazard which can cause damage to the unit or have a serious effect on the function or use of the unit if unobserved.



Important!

Indicates important information which must be observed during the described procedure.



Note!

Indicates notes, information or pointers, which facilitate work or provide additional background information or point out specific details.



Requirement!

Indicates requirements that must be met for the execution, activation, modification or deletion of the described function. These requirements must be met before proceeding.



SL 523

Indicates information regarding model type SL 523.



SL 525

Indicates information regarding model type SL 525.



Programming Software AS 254

Refers to the Programming Software AS 254 (optionally available), which allows additional settings and functions.



2.1.2 Navigation aids

The mentioned illustration A... can be found as from page A-2, at the front of the manual.



The mentioned illustration Z... can be found as from page Z-5, at the end of the manual.

2.1.3 Text markings

- The character „7“ stands for „see“, „refer to“ or „also consult“.
Sample: For description of Master Code 715.1 Codes on page EN-14.
- Text appearing on the display is marked in capitals and set into quotation marks.
Sample: „LOCKED“.
- Keys to be used are marked in bold capitals:
 - DEL** = Delete key
 - NUMERIC** = Numeric keys 0...9
 - INFO/ESC** = Information/Escape key
 - ENTER** = Enter key
 - MODE** = Mode key
 - LEFT** = Left arrow key
 - RIGHT** = Right arrow key

3 Installation and Connection



Important! Information and remarks

Please observe the following:

- **Compliance to described sequence is a necessity. Improper assembly or different sequence may cause damage to the unit!**
- **To avoid any damage make sure to keep cables away from moving parts! Do not lead cables over sharp edges!**
- **Do not close the safe door until all steps have been completed successfully!**
- **Removal of or damage to the warranty seal (illustration Z2, item ②) voids warranty!**
- **Removal of or damage to the VdS label (illustration Z2, item ①) voids VdS approval!**
- **For VdS and UL conformity lock must not be mounted directly behind leadthroughs! Clog or secure leadthroughs correspondingly (e.g. with the optional available anti-drill plate).**



3.1 Preparations and checks

Check content of package. Included are

- Input Unit
- Connection cable
- 3 batteries
- Lock
- Plastic bag containing installation material

3.2 Installation of Input Unit

Mount base plate

1. Remove screws (1 at battery compartment, 2 at cover) at lower end of Input Unit.
2. Lift-off cover from base plate and remove battery compartment.
3. Mark either fixation bores ② ④ ① or ③ ⑤ ① (recommended) and one of the bores ⑥ (cable leadthrough) using template (illustration Z1).
4. Drill 3x Ø3.2x14mm and 1x Ø10mm. Remove burrs. Tap 3x M4 threads.
5. Mount base plate with enclosed special M4x12 flat-head screws on positions ① ② ④ or ① ③ ⑤ (minimum of 2 oppositely positioned screws necessary).



Connect cables

6. Lead connection cable through Ø10mm bore and carefully draw it through door towards lock chamber.
7. Mount battery compartment in place and check for free movability.
8. Lead battery cable through strain relief guides of battery compartment and base plate (illustration Z3). **Make sure not to squeeze cable!**
9. Position cover on top of base plate in >90° angle (illustration Z4).
10. Plug battery cable into terminal **BATTERY J3** (illustration Z5).
11. Plug connection cable into terminal **LOCK J2** – white wire facing left (illustration Z5).



Mount cover

12. Engage cover at notch on top of base plate.
13. Slowly flip down cover onto base plate while carefully pulling connection cable towards the lock chamber; leave spare loop. **Make sure that cables are not squeezed.**
14. Push battery compartment carefully into place.
15. Carefully slide out battery compartment again until it catches at limit stop to check for free movability.
16. Fix cover on base plate using two M3x6 countersink screws.
17. Repeat step 15 to check for proper movability.

3.3 Installation of lock

Mount lock



1. Mark 3 bores using template (illustration Z2).
2. Drill Ø5mm. Remove burrs. Tap M6 threads.
3. Mount lock with 3 enclosed M6x10 screws. **Make sure that screw heads rest on base of shouldered bore! Make sure to keep space underneath lock clear for relocker system or connection cable!**
4. If lock is to be operated in spring bolt function, remove retainer screw underneath VdS label (illustration Z2, item ①). **Be aware, that this operating mode voids VdS approval!**
5. If needed, use 2x M4 threads at front end of lock bolt to attach an extension. **Observe maximal moving force of 5N in both directions (illustration Z2).**

Connect cable



6. Plug connection cable into upper lock socket Q1 (illustration Z7b) – white wire facing away from terminal block.
7. Secure any excess cable with cable tie (illustrations Z6aa, Z6b, Z6c).

Perform wiring check

8. Carefully slide out battery compartment until it catches at limit stop.
9. Insert 3 enclosed batteries (3x AA mignon, Alkaline type) according to markings in receptacles – **observe polarity!**
A test routine is initiated:
1st Full display appears.
2nd Software version of Input Unit is displayed.
3rd „BAT-CMP OPEN“ is displayed and „BEEP signal“ sounds.
10. Close battery compartment. „WAIT“ while display counts down.
11. Confirm message with factory set Master Code (00123456).
Lock status (e.g. „Open“ or „Locked“) must be displayed.
12. Fix battery compartment with countersink Allen screw.



Important!

Error messages

If message „LINE OFF“ appears, connection cable is either connected incorrectly or it was damaged during installation. Do not continue installation!

- **Check for correct connection of cable – if OK, proceed as follows:**
 - **Disconnect cable and get new one.**
 - **Proceed as described under section 3.2 Installation of Input Unit on page EN-8.**
- For other error messages 7.1 Error messages on page EN-29.**

3.4 External connections



If desired, connect external signals at lock terminal block and/or lock socket 2. Refer to below table and illustrations Z7aa (terminal layout), Z7b (lock sockets), Z8 (door contact) and Z9 (Controlled Disabling).

Terminal	Description	Capacity / Remarks
Note: Function and polarity can be changed with optional Programming Software AS 254.		
1 / 2	Output 2 std.: Bolt or motor open	30 VDC/2A, 50 VAC/0.5A with resistive load. Relay with potential-free working contacts (NO, normally open).
3 / 4	Output 1 std.: Duress alarm	
5(-) / 6(+)	Input 1 std.: not assigned. opt.: Remote Disabling, or Controlled Disabling.	12 VDC (min. 20mA)
7 / 8	Input 2 std.: Time Delay override (SL 523) / not assigned (SL 525) opt.: Door contact	Do not apply any voltage – potential free contact only! Recommendation: Suitable micro switch with gold-plated contacts for 12 VDC/50mA (e.g. „DB series“ by Cherry).
Socket	Description	Capacity / Remarks
Q1	Connection to input unit.	Use enclosed connection cable.
Q2	Input 3 std.: not activated. opt. (SL 525 only): Duress by omission.	Connection cable available as an option. Cable may be extended to max. 30 meters. Do not apply any voltage – potential free contact only! Recommendation: Suitable micro switch with gold-plated contacts for 12 VDC/50mA (e.g. „DB series“ by Cherry).

3.5 Commissioning

1. Close and secure battery compartment using enclosed M3x6 Allen screw.
2. Open lock by entering factory set Master Code (00123456).
3. Confirm with **ENTER**. Lock opens – „Open“ is displayed.
4. Close lock (**without closing the door!**) by pressing **DEL** or by activating the connected door contact.
5. The unit is now ready for programming and operation.

4 Operating and display devices / operating modes

4.1 Operation and display elements



4.1.1 Input Unit (illustration A1)

1. Housing
2. Interface for Audit Trail read-out or PC connection
3. Connection cable to lock
4. INFO/ESC key (activate info display or escape/go back to upper level)
5. ENTER key (enter, confirm)
6. MODE key (activate Programming Mode)
7. Battery compartment
8. LEFT / RIGHT (directional keys to navigate)
9. NUMERICS (10 numeric keys 0...9)
10. DEL (delete, close lock)
11. LCD (liquid crystal display)
12. Buzzer



4.1.2 Display (illustration A2)

1. Menu TIME (to set time/date)
2. Menu PROG (to program Locking Periods)
3. Menu DELAY (to program Time Delays)
4. Menu CODE (to modify codes)
5. Menu AUDIT (to read-out Audit Trail)
6. Menu MISC (to access additional settings)
7. Time format (12/24 Hrs.)
8. Text lines
9. Symbol „Warning“
10. Symbol „Replace batteries“
11. Symbol „Lock open“ (unlocked) or „Lock closed“ (locked)



Note! **Menu selection**
 The menus are only accessible in Programming Mode.
To enter Programming Mode 76.2 Operating on page EN-18.

4.2 Buzzer signals

Buzzer signal	Display	Cause
1 short beep		key stroke
1 short, low-frequency beep	REFUSED	action refused
1 short beep every 60 seconds	WAIT	Time Delay or Dures Time Delay active
3 short beeps every 60 seconds	CONF	Confirmation Window active (waiting for confirmation code after elapse of Time Delay)
10 short beeps every 10 seconds	BAT-CMP OPEN	battery compartment has been opened
10 short beeps every 30 seconds	OPEN	lock open

Table 2: Buzzer signals



Programming Software AS 254

Buzzer signal during „OPEN“ can be deactivated,
 buzzer volume may be set to high, low or off.

4.3 Status messages

During normal operation following messages can occur:



4.3.1 Locked

The lock is mechanically closed – the current time is displayed. It may be opened by entering a valid code.



4.3.2 Open

The lock is mechanically open. The boltwork or the safe door can be opened during a time window of 6 seconds. If the boltwork is not opened, the lock automatically closes after 6 seconds.

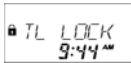

4.3.3 Time lock (Weekly)

The lock is in a Weekly Locking Period or in Immediate Locking and cannot be opened – the current time is displayed. It may only be opened by entering a valid code once the programmed Locking Period has elapsed.



4.3.4 Time lock (Holiday)

The lock is in a Holiday Locking Period and cannot be opened – the current time is displayed. It may only be opened by entering a valid code once the programmed Locking Period has elapsed.

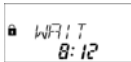

4.3.5 Time Delay

After entering a valid code to open the lock the programmed Time Delay starts counting down – the remaining time is displayed. A „BEEP signal“ is emitted every 60 seconds. Once the counter has reached 00:00, the end of the Time Delay is indicated with another „BEEP signal“.

*Remark: If DEL is pressed, the Time Delay is reset and the lock automatically returns to „locked“ status.
The Courier Code overrides a Time Delay.*



4.3.6 Confirmation after elapse of Time Delay

Once Time Delay has elapsed, within a programmed time window the same code must be entered again as confirmation. The remaining time allowance to enter the code is displayed. An „BEEP signal“ is emitted every 60 seconds. If the code is not confirmed, the lock automatically returns to locked status once counter reached 00:00.

Remark: With Dual Mode during Time Delay proceed as follows: Repeat both codes for confirmation, whereby the sequence is irrelevant.



4.3.7 Dual Mode

If Dual Mode is activated, 2 codes must be entered to open the lock. Entering of second code is requested with this message.

Remark: Master Code and Courier Code override the Dual Mode – the lock can be opened without any additional code.

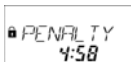

4.3.8 Penalty after wrong trials

A time penalty of 5 minutes is initiated after the fourth consecutive incorrect code is entered upon opening or programming. During this period no code entries are accepted, neither bypassing nor cancellation is possible. The remaining penalty time is displayed.

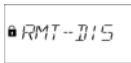

4.3.9 Remote Disabling

Local opening of the lock can be disabled by a remote signal. While Remote Disabling is active this message is shown while the lock is closed.



4.3.10 Identification with denied code

Codes can be denied with a superior code, i.e. declared as invalid until possible further re-permission. Identification with a denied code is answered with this message. The selected function is not executed, the lock condition remains unchanged. This message is also displayed upon attempting to open with Master Code if „Master cannot open“ is set.



4.3.11 Audit Trail

The last 2400 events (e.g. opening, closing, programming operations etc.) are stored in the lock's power-failure proof memory. These data can be read-out (special cable and software optionally available) and viewed on an external computer. During output of the event data this message is displayed.

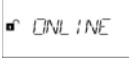

4.3.12 Connected with Programming Software

While the lock is connected to an external computer (Programming Software AS 254 optionally available) this message is displayed. The Input Unit is not operative, all keys are disabled.

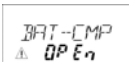

4.3.13 The battery compartment has been opened!

If the battery compartment, which also serves as a dismantling protection for the Input Unit, has been opened. This message appears when

- lock is open while battery compartment is open, and when
- lock is locked and the battery compartment has been opened and closed again.

The message can only be deleted by entering a valid Master Code or Manager Code.

4.4 Operating modes

4.4.1 Normal operation mode

Normal mode for opening/closing operation. All programmed functions are carried out, alarms will be supported and forwarded, diagnose is carried out and possible errors are displayed with a message.

4.4.2 Programming mode

Mode to alter factory set parameters and to change settings, codes etc. Depending on programming level different codes are required.

4.4.3 Information menu

The information is accessible by pressing the **INFO/ESC** key while the display shows "open" or "locked". Pressing **INFO/ESC** will initiate an 6 second auto-display showing...

- opening counter,
- battery level (% of nominal capacity),
- Code entry format (ID+PIN or PIN+ID).

*Remark: Pressing **INFO/ESC** again will move one step ahead.*

5 Operation

5.1 Codes

5.1.1 Code hierarchy and entry formats

For operation and programming Master Code, Manager Codes, User Codes and Courier Code are available. Each code consists of an 8 digit number set together of an **ID** (identification) **and** a **PIN** (Personal Identification Number).

- The ID (2 digits) is pre-defined and identifies the code type.
- The PIN (remaining 6 digits) can be individually chosen.



Note!

ID+PIN or PIN+ID format

With the Programming Software AS 254 the sequence to enter a code can be changed from ID followed by PIN to PIN followed by ID.

Through the entire description of this manual the code format ID+PIN format (ID followed by PIN) is used.



Programming Software AS 254

Entry format ID+PIN can be changed to PIN+ID. Information on code format used is available with **INFO/ESC** key (74.4.3 Information menu on page EN-13).

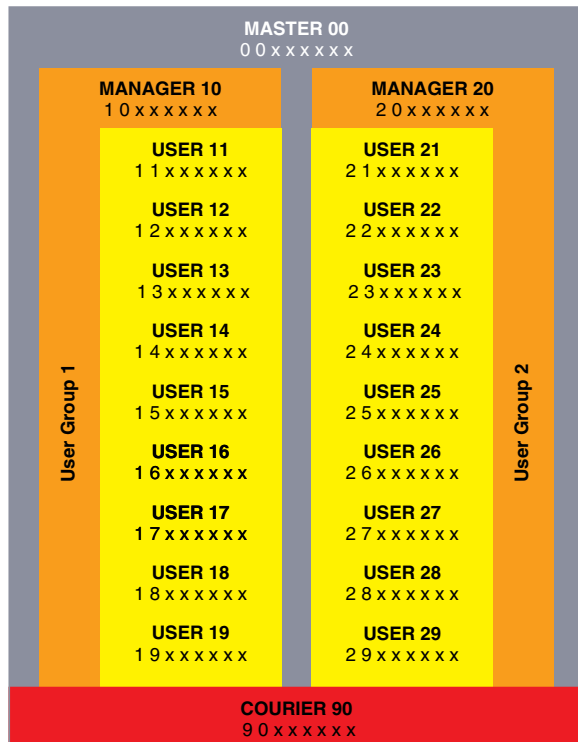

5.1.2 Code types

The factory set Master Code 0 0 1 2 3 4 5 6 is identical on all locks of this type, and therefore not suitable for daily use.

Upon initialization and testing the Master Code must be changed from factory set value and set to individually selected values.



Important! *Personalization of codes*

During commissioning and start-up of the unit all codes must be personalized.

Never use any simple combination of numbers (e.g. 11223344, 12345678) or personal data (e.g. birthdays). For safety reasons, codes should be altered at regular intervals!

5.1.2.1 Master Code

The Master Code is the highest code within the code hierarchy. It **cannot** be deleted.

Factory setting: 0 0 1 2 3 4 5 6

Functions: Opening the lock (even alone in Dual Mode)
 Alteration of all codes
 Accessing full range of function



Programming Software AS 254

The Master Code can be defined as „cannot open the lock“. Thereupon, entering the Master Code for lock opening is confirmed with the message „DENIED“ – the lock does not open.



Warning! *Lost codes*

Lost codes can only be deleted and redefined with a higher-level code.

Please take note, that a lost Master Code can neither be located nor restored under any circumstances. There is no so called „Override code“ or „Super code“!

5.1.2.2 Manager Codes

2 Manager Codes (Manager Code 1, Manager Code 2) are available. Each Manager Code can administrate a group of User Codes.

Factory setting: no code assigned

Functions: Opening the lock
 Alteration of own Code
 Activation, deletion and alteration of subordinated User Codes
 Denial and permission of subordinated User Group
 Alteration of subordinated Time Delay and Confirmation Window
 Activation of Immediate Time Lock function

5.1.2.3 User Codes

A total of 18 User Codes in 2 groups of up to 9 each can be defined. User Codes can be defined even if no Manager Code is active.

Factory setting: no code assigned

Functions: Opening the lock
 Alteration of respective User Code

5.1.2.4 Courier Code

1 Courier Code can be provided to personnel filling/emptying secured containers (CIT (Cash-In-Transit Services)) without any programmed Time Delays being of relevance.

Factory setting: no code assigned

Functions: Opening the lock (even alone in Dual Mode) by bypassing Time Delay
 Alteration of Courier Code

5.1.3 Shelf Function

All codes, parameters and data (e.g Locking Periods, Time Delays etc.) are reset to factory settings. Audit Trail and opening counter remain unchanged. This function is only available if Programming Mode is accessed with Master Code.

5.1.4 Duress Code

If the lock is connected to an external alarm system, a silent duress alarm (unnoticeable for the aggressor) can be initiated by the operator.

To trigger a duress alarm, the **value 1 has to be added or deducted to the last digit of the code**. Duress alarms can be initiated with all code types at any time.

Entering the Duress Code for each lock opening starts the programmed Duress Time Delay.



Requirement! *Enabling/disabling Duress Code*
Duress Codes are recognized only if this function is enabled by the Master Code (7.6.4.6.3 Submenu DURESS (enabling Duress Code function) on page EN-27).



Important! *PIN+ID format*
 With PIN+ID entry sequence changes.
To trigger a duress alarm, value 1 has to be added or deducted to the first digit of the code!



Note! *Duress status period*
After entering a Duress Code, the duress status is maintained until the lock has been opened once with a non-duress code!



Programming Software AS 254

Two Duress Time Delays are available: the first is valid for Master, Manager 1 and Users 11 ... 19, the second for Manager 2 and Users 21 ... 29.

The Duress Time Delays can be set independent (longer or shorter) of normal Time Delays.



SL 523

With the SL 523 there are no Duress Time Delays available. Time delays remain the same if a Duress Code is entered.

5.2 Code entry

Codes are entered in 2 groups of 4 digits. To enter a code proceed as follows:

1. Key-in the first 4 digits of the code.
2. Continue by keying-in second 4 digits of the code.
3. Complete code entry by pressing **ENTER**.

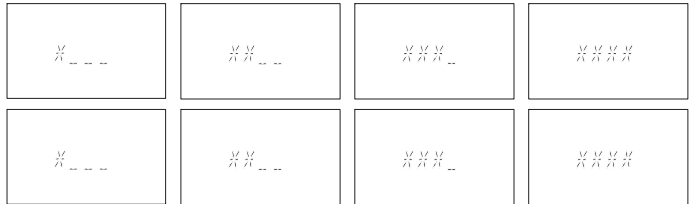

Note! *Phantom Code / Diverting manoeuvre*
 During code entry a possible observer can be diverted. Only **the first 7 and the last** entered digit will be considered as a code.

- Enter your code as usual (at least the first 7 digits) and keep on adding any combination as desired.
- Enter the last digit of your code and press **ENTER**.

5.3 Opening procedure

Display switches off automatically after 3 minutes without any key being pressed.

1. Wake-up display by pressing any key. Status message appears.
2. Enter code with **NUMERICS**. An asterisks appears for every digit entered.
3. If unit is set to Dual Mode enter second code.
4. Open lock by confirming with **ENTER**.
5. Open container.
6. If desired continue in Programming Mode (↗as from page EN-18).

**Note!****Denied opening**

Opening is not possible during following conditions:

- **Penalty after wrong trials** (↗page EN-12).
- **During active Locking Period** (↗page EN-12).
- **During Remote Disabling is in process** (↗page EN-12).
- **Active connection with the Programming Software** (↗page EN-13).

5.4 Closing procedure

The lock normally closes automatically when the boltwork is closed.

**Note!****Additional closing options**

Depending on the safe design the closing procedure can be made dependent on additional factors.

Contact the supplier of the safe or consult section 3 Installation and Connection on page EN-8.

6 Programming

6.1 Menus and submenus

Following menu and corresponding submenus are available in Programming Mode:



Menu TIME (to set time/date)

Submenus: „TIME“, „DATE“, „AM/PM“



Menu PROG (to program Locking Periods)

Submenus: „WEEKLY“, „IMM-TL“, „HOLIDAY“



Menu DELAY (to program Time Delays)

Submenus: „DELAY 1“, „DELAY 2“, „CNF WIN“



Menu CODE (to modify codes)

Submenus: „MASTER“, „MANAGER“, „USER“, „COURIER“, „SHELVE“



Menu AUDIT (to read-out Audit Trail)

Submenu: „START ?“, „YES“ and „NO“



Menu MISC (to access additional settings)

Submenus: „CDE DEN“, „RMT-DIS“, „DURESS“, „DUAL“, „LANG“

6.2 Operating

6.2.1 Activate Programming Mode

1. Open lock (75.3 Opening procedure on page EN-17).
2. Press **MODE**.
3. Enter code.
4. Confirm with **ENTER**.

Programming Mode is now activated. Selectable menus according to entered code are displayed.

6.2.2 Navigate in Programming Mode

5. Scroll with **LEFT** and **RIGHT** to desired menu.
6. Confirm selection with **ENTER**.
Menu is now open. First submenu is displayed.
7. Scroll with **LEFT** and **RIGHT** to desired submenu.
8. Confirm selection with **ENTER**.
Settings or functions are now displayed.

6.2.3 Change settings in Programming Mode

9. To program individual settings and functions follow the corresponding description as described as from Chapter 6.4 Programming procedures on page EN-20.
10. Perform programming procedures.
11. Move with **LEFT** and **RIGHT** to „YES / NO“ or „ON / OFF“, then press **ENTER** to store selected setting.
12. Saving of data is confirmed with a message “accepted” on the display.

6.2.4 Quit Programming Mode

13. Press **INFO/ESC**.
Next higher menu level is displayed.

6.2.5 Exit

14. Press **MODE** and confirm with **ENTER**
or press **INFO/ESC** until Programming Mode is aborted.

Display switches off automatically after 1 minute without any key being pressed.



Important! *Loss of data*
Any changes which have not been confirmed with „Accepted“ will be lost!

6.3 Access rights

Depending on lock status and code used upon activating Programming Mode following entries and settings can be made:

Function	Authorization				Lock		Remarks
	MA	Mx	U	C	o	c	
Set Date	✓				✓		
Set Time	✓				✓		
Set Time format	✓				✓		
Set Weekly Locking Period	✓				✓		
Activate Immediate Time Lock function	✓	✓			✓		
Set Holiday Locking Period / repeated Holiday Locking Period	✓				✓		
Set Time Delays	✓	✓			✓		Master: Time Delays 1 and 2 Manager 1: Time Delay 1 Manager 2: Time Delay 2
Set Confirmation Window	✓	✓			✓		
Change Master Code	✓				✓		Master Code cannot be deleted!
Change Manager Code	✓	✓			✓		
Delete Manager Code	✓				✓		Respective User Codes will not be deleted!
Change Courier Code	✓			✓	✓		
Delete Courier Code	✓				✓		
Delete User Codes	✓	✓			✓		
Change User Code	✓	✓	✓		✓		User can only change own code!
Employ Shelve Function	✓				✓		
Read-out Event Memory	✓				✓	✓	
Deny/permit subordinated codes	✓	✓			✓		Entire group of User Codes will be denied/permitted!
Activate/deactivate Remote Disabling	✓				✓		
Activate/deactivate Duress Code	✓				✓		
Activate/deactivate Dual Mode	✓				✓		
Change Display Language	✓				✓		

Table 3: Access rights

Legend: MA Master Code U User Code o open
Mx Manager Code 1, 2 C Courier Code c closed

6.4 Programming procedures



Requirement!

Preconditions

Following criteria must be fulfilled to enable programming:

- **Lock must remain open during entire programming procedure.**



Important!

Auto switch-off

After an operating pause of 1 minute the display will be turned off – Programming Mode will automatically be exited. Any unsaved entries will be lost!

While programming, make sure to strike any key within 1 minute.



6.4.1 Menu TIME (to set time/date)

Submenus: „TIME“, „DATE“, „AM/PM“

6.4.1.1 Submenu TIME (changing time)

Authorization: Master Code

1. Select submenu „TIME“.
2. Press **ENTER**. Currently set time appears.
3. Enter time using **NUMERIC**. After each number cursor moves automatically one digit to the right. If needed scroll **LEFT** and enter again.
4. Confirm with **ENTER**.



Note!

Time format

Possible entries depend on AM/PM setting (76.4.1.3 Submenu AM/PM (setting time format) on page EN-20).

If AM/PM is activated, time must be entered in 12-Hour-Format (e.g. 14:25 as 02:25 PM). The suffix AM or PM can be selected with RIGHT.

6.4.1.2 Submenu DATE (changing date)

Authorization: Master Code

1. Select submenu „DATE“.
2. Press **ENTER**. Currently set date appears
3. Enter month (January=01, February=02, ... December=12) and day with 2 digits, year 4 digits using **NUMERIC**. After each number cursor moves automatically one digit to the right. If needed scroll **LEFT** and enter again.
4. Confirm with **ENTER**.



Note!

Date/time display

Within the display navigation between day, month and year is performed with **LEFT** and **RIGHT**. Respective weekdays and leap years are automatically calculated.

- **Execute changes at flashing digit.**
- **Select date of internal calendar between Jan-1-2002 and Dec-31-2099.**

6.4.1.3 Submenu AM/PM (setting time format)

Authorization: Master Code

1. Select submenu „AM/PM“.
2. Select either „ON“ or „OFF“ by scrolling with **LEFT** / **RIGHT**.
3. Confirm with **ENTER**.



Note!

Time format

Entry formats depend on selected time format.

- **With „ON“ time is displayed in 12-Hour-Format (1:00 – 12:59 with suffix AM (ante meridiem = before noon) or PM (post meridiem = after noon).**
- **With „OFF“ time is displayed in 24-Hour-Format (00:00 – 23:59).**



6.4.2 Menu PROG (to program Locking Periods)

Submenus: „WEEKLY“, „IMM-TL“, „HOLIDAY“

6.4.2.1 Submenu WEEK (programming Locking Periods)

Up to 16 weekly repeated time windows can be defined, during which the lock cannot be opened (e.g. outside business opening hours).

Authorization: Master Code

6.4.2.1.1 Adding a Weekly Locking Period

1. Select submenu „WEEKLY“.
If any Locking Periods are already programmed, beginning of first Locking Period will appear.
2. **LEFT** or **RIGHT** until „<-- + -->“ is displayed.

Note: If total number of Locking Periods (max. 16) is exceeded „<-- --->“ will appear.

To insert 12:00 AM in 12hrs. mode, select 00:00 AM!

3. Press **ENTER**.
4. Use **NUMERICS** for day and time
(if AM/PM format: Sunday=1, Monday=2, ... Saturday=7;
if 24-hours format: Monday=1, Tuesday=2, ... Sunday=7).

Note: The „lock closed“ symbol indicates the first day of a Locking Period, the „lock open“ symbol indicates its last day.

5. Confirm with **ENTER**.



Note! Formats, limitations and restrictions

- Weekly Locking Periods can last 1 minute to 6 days, 23 hours and 59 minutes.
- Between two Weekly Locking Periods a time gap of at least 1 minute must be observed.
- Between two Locking Periods opening must be possible. Therefore time gap must be larger than programmed Time Delay (or Duress Time Delay, if larger), plus Confirmation Window, plus one additional minute.
- Time entry and day entry depend on the AM/PM setting (↗page EN-20).
- Weekly Locking Periods are saved in chronological order, starting with Monday.
- Navigate between programmed Weekly Locking Periods using **LEFT** and **RIGHT**.

6.4.2.1.2 Changing an existing Weekly Locking Period

1. Select submenu „WEEKLY“.
2. Press **ENTER**.
3. **LEFT** and **RIGHT** until start of the Weekly Locking Period you wish to alter.
4. Press **ENTER**.
5. Use **NUMERICS** for day
(if AM/PM format: Sunday=1, Monday=2, ... Saturday=7;
if 24-hours format: Monday=1, Tuesday=2, ... Sunday=7) and time to set start.
Skip entries you wish to keep with **RIGHT**.
6. Confirm with **ENTER**. End of the Locking Period is displayed.
7. Use **NUMERICS** or **RIGHT** as above and confirm with **ENTER**.

6.4.2.1.3 Deleting an existing Weekly Locking Period

1. Select submenu „WEEKLY“.
2. Press **ENTER**. Start of the first programmed Weekly Locking Period is displayed.
3. **LEFT** and **RIGHT** until start of the Weekly Locking Period you wish to delete.
4. Press **DEL**.

6.4.2.2 Submenu IMM-TL (programming Immediate Time Lock)

The function permits activation of a Locking Period with immediate action. Upon closing the lock **cannot** be opened until the next programmed Weekly Locking Period has elapsed. Example: For shorter business hours due to public holiday, the time until beginning of the regular Locking Period can be bridged.

Authorization: Master Code or any Manager Code

1. Select submenu „IMM-TL“.
2. Press **ENTER**.

6.4.2.3 Submenu HOLIDAY (programming Holiday Locking Periods)

The function permits defining of up to 22 date-related time windows, during which the lock cannot be opened (e.g. during holidays or on public holidays).

Authorization: Master Code

6.4.2.3.1 Adding a Holiday Locking Period

1. Select submenu „HOLIDAY“.
2. Press **ENTER**.

Note: If any Locking Periods are already programmed, beginning of first Locking Period will appear.

3. **LEFT** or **RIGHT** until „<-- + -->“ is displayed.
4. Press **ENTER**.
5. Use **NUMERICS** for month (January=01, February=02, ... December=12), day and year to set the first day of locking period. Skip entries you wish to keep with **RIGHT**.
6. Confirm with **ENTER**. Last day of the Locking Period is displayed.
7. Use **NUMERICS** or **RIGHT** as above.
8. Confirm with **ENTER**.



Note! *Formats, limitations and restrictions*

- **Holiday Locking Periods last from 00:00:00 (12:00 AM) of the first day until 23:59:59 (11:59:59 PM) of the last day.**
- **Maximum duration of a Holiday Locking Period is limited to 35 days.**
- **Between two Holiday Locking Periods a time gap of at least 1 day must be observed. Exception: Feb 28th – March 1st due to leap year.**
- **Holiday Locking Periods are saved in chronological order.**
- **During an active Holiday Locking Period previously programmed Weekly Locking Periods (76.4.2.1 Submenu WEEK (programming Locking Periods) on page EN-21) have no effect – the Holiday Locking Period is simply overlaid.**



Note! *Hints and Tips*

- **Entering „0000“ for both, starting and ending year will repeat the Holiday Locking Period every year.**
- **If the end date of a yearly repeated Holiday Locking Period is to be last day of February, it is recommended to set it to February 29th in order to include leap years as well.**

6.4.2.3.2 Changing an existing Holiday Locking Period

Proceed as described for adding a new Holiday Locking Period (76.4.2.3.1 Adding a Holiday Locking Period on page EN-22). Instead of „<-- + -->“ select the Holiday Locking Period you wish to alter and overwrite it.

6.4.2.3.3 *Deleting an existing Holiday Locking Period*

Proceed as described for deleting a Weekly Locking Period (➔page EN-21).



Important! *Automatic deletion upon completion*
Once elapsed, Holiday Locking Periods are automatically deleted!
This also applies if the date is accidentally set to a future date and then reset to a date in the past!



6.4.3 Menu DELAY (to program Time Delays)

Submenus: „DELAY 1“, „DELAY 2“, „CNF WIN“

6.4.3.1 Submenu DELAY 1/2 (programming Time Delays)

Once a valid code is entered, the lock only opens when the programmed time delay has elapsed. A delay can be set between 0 (deactivated, no delay) and 99 minutes. Seconds are not taken into account. Two Time Delays can be programmed: Time Delay 1 is valid for Master, Manager 1 and Users 11 ... 19; Time Delay 2 is valid for Manager 2 and Users 21 ... 29.

Authorization: Master Code or Manager Code

6.4.3.1.1 Changing Time Delays

1. Select submenu „DELAY 1“ or „DELAY 2“.
2. Press **ENTER**. Current Time Delay duration appears.
3. Use **NUMERICS** to set duration.
4. Confirm with **ENTER**.

6.4.3.1.2 Deactivating Time Delays

Proceed as described above. Set delay duration to 00:00.



Note! *Factory setting / Override by Courier Code*
 • **Upon delivery Time Delays are deactivated (00:00).**
 • **Entering a Courier Code always opens the lock without any Time Delay.**



Programming Software AS 254

Two Duress Time Delays can be programmed: the first is valid for Master, Manager 1 and Users 11 ... 19, the second for Manager 2 and Users 21 ... 29. The Duress Time Delays can be set independent (longer or shorter) of normal Time Delays.

It is also possible to suppress Time Delays with an external signal (see section 1.5.2 Electronics on page EN-4 „Inputs“). This allows to open the lock (e.g. to empty ATMs) without a Time Delay.

It is also possible to automatically trigger the Duress Time Delay. This is the case if no external signal was triggered – e.g., by a push-button – within 1 minute before a code-entry to open (function Duress by Omission, see section 1.5.2 Electronics on page EN-4 „Inputs“).

6.4.3.2 Submenu CNF WIN (programming Confirmation Window)

To prevent the lock from automatic opening once a Time Delay has elapsed, the same code has to be entered again within a certain time window.

Authorization: Master Code or any Manager Code

6.4.3.2.1 Changing the Confirmation Window

1. Select submenu „CNF WIN“.
2. Press **ENTER**. Current value is displayed.
3. Use **NUMERICS** to set duration.
4. Confirm with **ENTER**.



Note! *Factory setting / Limitations*
 • **Upon delivery Confirmation Window is set to 5 minutes.**
 • **Confirmation Window value must be set 1...99 minutes (can not be deactivated).**



6.4.4 Menu CODE (to apply and modify codes)

Submenus: „MASTER“, „MANAGER“, „USER“, „COURIER“, „SHELVE“

The following table shows the authorizations of codes to perform modifications (for an overview of available code types and their respective formats ↗page EN-14).

Master Code	Manager Codes	User Codes	Courier Code	can be modified by owner of...
C	A C D	A C D	A C D	Master Code
-	C	A C D	-	respective Manager Code
-	-	C	-	respective User Codes
-	-	-	C	Courier Code

Table 4: Possible code modifications

Legend: A Activate C Change D Delete

6.4.4.1 Submenu MASTER (programming Master Code)

Authorization: Master Code

1. Select submenu „MASTER“.
2. Press **ENTER**.
3. Select „YES“ and confirm with **ENTER**.
4. Use **NUMERICS** to enter new code (observe entry format – ↗page EN-14).
5. Confirm with **ENTER**. „CONFIRM“ is displayed.
6. Use **NUMERICS** to confirm new code.
7. Confirm with **ENTER**.

6.4.4.2 Submenu MANAGER (programming Manager Codes)

Authorization: Master Code or respective Manager Code

1. Select submenu „MANAGER“.
2. Press **ENTER**.
3. If authorization with Master Code: **LEFT** and **RIGHT** to the Manager you wish to alter (Manager Codes already activated are displayed by „USED“). Press **ENTER**.
4. Select „YES“ and confirm with **ENTER**.
5. Use **NUMERICS** to enter new code (observe entry format – ↗page EN-14).
6. Confirm with **ENTER**. „CONFIRM“ is displayed.
7. Use **NUMERICS** to confirm new code.
8. Confirm with **ENTER**.

6.4.4.3 Submenu USER (programming User Codes)

Authorization: Master Code, respective Manager Code or respective User Code

If authorization with User Code proceed directly to step 6.

1. Select submenu „USER“.
2. Press **ENTER**.
3. **LEFT** and **RIGHT** to the User you wish to alter (User Codes already activated are displayed by „USED“).
4. Press **ENTER**.
5. Select „YES“ and confirm with **ENTER**.
6. Use **NUMERICS** to enter new code (observe entry format – ↗page EN-14).
7. Confirm with **ENTER**. „CONFIRM“ is displayed.
8. Use **NUMERICS** to confirm new code.
9. Confirm with **ENTER**.

6.4.4.4 Submenu COURIER (programming Courier Code)

Authorization: Master Code or Courier Code

If authorization with Courier Code proceed directly to step 3.

1. Select submenu „COURIER“.
2. Press **ENTER**. Activated Courier Code is displayed with „USED“. Select „YES“ and confirm with **ENTER**. If no Courier Code is programmed („-----“) is shown. Press **ENTER** again.
3. Use **NUMERICS** to enter new code (observe entry format – 7page EN-14).
4. Confirm with **ENTER**. „CONFIRM“ is displayed.
5. Use **NUMERICS** to confirm new code.
6. Confirm with **ENTER**.

6.4.4.5 Submenu SHELVE (employing Shelf Function)



Important! Shelf Function

Employment of the Shelf Function will erase all codes and will set all parameters, such as Time Delay, Time Lock function, Dual Mode, display language, inputs, outputs etc. to factory set values. Time/date, opening counter and Audit Trail will remain unchanged.

- **Before continuing, be aware that all data will be lost!**
- **Saving data with Programming Software AS 254 prior shelving is recommended!**
- **Take note that codes cannot be saved!**

Authorization: Master Code

1. Select submenu „SHELVE“.
2. Press **ENTER**.
3. Select „YES“ and confirm with **ENTER**.

6.4.4.6 Changing a code

Authorization: 75.1 Codes on page EN-14

1. Select submenu „CODE“.
2. Press **ENTER**.
3. **LEFT** and **RIGHT** to the code type you wish to alter. If the Programming Mode was entered with a higher level code, press **ENTER** again and use **LEFT** and **RIGHT** to the code you wish to alter and press **ENTER** again.
4. Select „YES“ and confirm with **ENTER**.
5. Use **NUMERICS** to enter new code (observe entry format – 7page EN-14).
6. Confirm with **ENTER**. „CONFIRM“ is displayed.
7. Use **NUMERICS** to confirm new code.
8. Confirm with **ENTER**.

6.4.4.7 Deleting a code

Authorization: 75.1 Codes on page EN-14

1. Select submenu „CODE“.
2. Press **ENTER**.
3. **LEFT** and **RIGHT** to select code type you wish to delete. If the Programming Mode was entered with a higher level code, press **ENTER** again and use **LEFT** and **RIGHT** to the code you wish to delete.
4. Press **DEL**.
5. Select „YES“ and confirm with **ENTER**.



Note! Limitations

- **The Master Code cannot be deleted.**
- **Upon deletion of a Manager Code the corresponding group of User Codes remain unchanged and will not be deleted.**



6.4.5 Menu AUDIT (to read-out event memory)

Authorization: Master Code

Precondition: This operation can also be executed while the lock is closed by pressing **MODE** and entering the Master Code.

1. „START?“ is displayed.
2. Confirm with **ENTER**.

Remark: The actual content of the event memory is now output via the serial interface to a logging device (e.g. PC, printer).

3. The following is shown on the display: „STOP ?“. The event data are output. The number of output events is shown continuously on the display. To quit press **DEL**, **INFO/ESC** or **ENTER** again. When all events have been output, the message „DONE“ appears.



6.4.6 Menu MISC (to access additional settings)

Submenus: „CDE DEN“, „RMT-DIS“, „DURESS“, „DUAL“, „LANG“

6.4.6.1 Submenu CDE DEN (programming Code Denial)

A higher-level code can deny access for lower-leveled codes until possible re-permission. As an example, „Off-Duty-Shifts“ can be locked out and reassigned again once they start their shift.

An entire User Group (with or without its corresponding Manager Code) can be declared invalid.

Authorization: Master Code or any Manager Code

1. Select submenu „CDE DEN“.
2. Press **ENTER**.
3. **LEFT** and **RIGHT** to desired User Group or Manager.
4. Confirm with **ENTER**.
5. Select „ON“ for denial (**access not authorized**) or „OFF“ for permission (**access authorized**) and confirm with **ENTER**.

6.4.6.2 Submenu RMT-DIS (programming Remote Disabling)

Operation of the closed lock can be inhibited by an external signal. This function can e.g. be employed when additional identification (e.g. badge, biometrics) is desired or to prevent opening during certain circumstances (e.g. when alarm system is armed).



Note! Limitations

- The function is not active when lock is open – lock can then be operated normally.

Authorization: Master Code

1. Select submenu „RMT-DIS“.
2. Press **ENTER**.
3. Select „ON“ for activation (**Remote Disabling possible**) or „OFF“ for deactivation (**Remote Disabling not possible**) and confirm with **ENTER**.

6.4.6.3 Submenu DURESS (enabling Duress Code function)

If the lock is connected to an external alarm system, a silent duress alarm (not noticeable for the aggressor) can be triggered (7.5.1.4 Duress Code on page EN-16).

Duress Codes are recognized if this function has been enabled by the Master Code.

Authorization: *Master Code*

1. Select submenu „DURESS“.
2. Press **ENTER**.
3. Select „ON“ for activation (**Duress Code entry possible**) or „OFF“ for deactivation (**Duress Code entry not possible**) and confirm with **ENTER**.



Programming Software AS 254

Duress Time Delay can be set independent (longer or shorter) of Time Delay.

It is also possible to automatically trigger a duress alarm. This is the case if no external signal was triggered – e.g., by a push-button – within 1 minute before a code-entry to open (function Duress by Omission, see section 1.5.2 Electronics on page EN-4 „Inputs“).

6.4.6.4 Submenu DUAL (enabling Dual Mode)

The lock can be set to require 2 codes for opening. It can be employed when only 2 persons together are supposed to be able to open the lock.

Authorization: *Master Code*

1. Select submenu „DUAL“.
2. Press **ENTER**.
3. Select „ON“ for activation (**Dual Mode active**) or „OFF“ for deactivation (**Dual Mode not active**) and confirm with **ENTER**.

Following code combinations for opening in Dual Mode are possible:

If no Time Delay is programmed	If a Time Delay is programmed	
	Codes to open the lock	Codes to start the Time Delay
MASTER	MASTER	MASTER
MANAGER and MASTER	MANAGER and MASTER	MANAGER and MASTER
MANAGER and COURIER	MANAGER and MASTER	MASTER
2 MANAGER	MANAGER and COURIER	MANAGER and COURIER
MANAGER and USER	MANAGER and COURIER	COURIER
USER and MASTER	2 MANAGER	2 MANAGER
2 USER	MANAGER and USER	MANAGER and USER
USER and COURIER	USER and MASTER	USER and MASTER
COURIER	USER and MASTER	MASTER
	2 USERS	2 USERS
	USER and COURIER	USER and COURIER
	USER and COURIER	COURIER
	COURIER	-

Table 5: Possible code combinations in Dual Mode



Note! Limitations

- **Once the Time Delay has elapsed, both codes must be entered again for verification – codes can be entered in any sequence.**
- **Master Code and Courier Code can open the lock without any second code.**
- **If Master Code or Courier Code is entered first, no second code will be required upon confirmation.**
- **If two codes were entered, the opening delay of the last code will be performed.**
Exception: if the first entered code was a Duress Code, its Duress Time Delay will be performed.



Programming Software AS 254

Master Code can be defined as „cannot open“. If so, it can neither be used to open the lock nor to start the Time Delay. Message „DENIED“ is shown instead. However, if only one operable code is programmed in Dual Mode, Master Code can open, though!

6.4.6.5 Submenu LANG (changing display language)

By default the system language is set to English. If desired, other languages can be selected. (71.5.5 Factory settings on page EN-6)

Authorization: Master Code

1. Select submenu „LANG“.
2. Press **ENTER**. Selection „ENGLISH“ is displayed.
3. Use **LEFT** or **RIGHT** to select desired language. Press **ENTER** to confirm.

7 Maintenance

7.1 Error messages

Operating errors, false entries or possible defects can result in error messages. Their significance and most possible cause are described in table below.

Display	Menu	Submenu	Cause
BAT-CMP OPEN			Battery compartment has been opened.
LINE OFF			Connection between lock and Input Unit is interrupted.
ID ERR	CODE	MASTER MANAGER USER COURIER	ID is not „00“ ID is not „10“ or „20“ ID is not „11...19“ or „21...29“ ID is not „90“
REFUSED	CODE	MASTER MANAGER USER COURIER	Code change: Code entered did not match the code entered first.
REFUSED 04	PROG	IMM-TL	No Weekly Locking Period programmed.
	after confirmation of an entry in Programming Mode		Lock is closed (programming possible with lock open only!)
REFUSED 08	TIME	DATE	<ul style="list-style-type: none"> Invalid date (e.g. Sep 31st). Date out of limit (Jan 1st 2002 until Dec 31st 2099).
	PROG	WEEK	Time window too long (max. 6 days, 23 hours, 59 minutes).
	PROG	HOLIDAY	<ul style="list-style-type: none"> Time window too long (max. 35 days) End date before start date Invalid date (e.g. Sep 31st) Date out of limit (Jan 1st 2002 until Dec 31st 2099)
REFUSED 16	PROG	WEEK	Minimum interval (pause) of 1 day until start of next Weekly Locking Period ignored. Also observe delay / confirm window limits.
	PROG	HOLIDAY	Minimum interval (pause) of 1 day until start of next Weekly Locking Period ignored. Also observe delay / confirm window limits.
	PROG	DELAY	Observe delay / confirm window limits in relation to Weekly and Holiday Locking Periods. The minimum time period is calculated by adding the confirmation window plus one minute to the bigger value of the two delay times (time delay or duress time delay).
REFUSED 32	PROG	WEEK	Memory full (max. 16 Weekly Locking Periods)
	PROG	HOLIDAY	Memory full (max. 22 Holiday Locking Periods)
MOT FLT			Motion Fault during bolt movement. <ul style="list-style-type: none"> Reboot unit by removing batteries for one hour and inserting new batteries. Check if bolt movement is smooth or if bolt is mechanically blocked call vendor for tech support (replace lock)
HDW FLT			Hardware fault: Proceed as with MOT FLT.
OVFLW AUdit			More than 2400 events occurred within the last 7 days, therefore manipulation is suspected. Only Master Code or Manager Codes allowed for confirmation of this error message. For opening Courier Code stays valid, all User Codes are denied. Proceed with <ul style="list-style-type: none"> Read-out Audit Trail. Set clock close before midnight. Let clock run over midnight. Set clock back to actual time.
VERSION Err			Input Unit and lock are not compatible. They bear different versions.

Table 6: Error messages

7.2 Servicing

7.2.1 Replacing batteries

The SL 523 and SL 525 models are powered by 3 **1.5 Volt ALKALINE batteries (type AM3, AA)** with a service life of approximately 3 to 4 years.



Batteries must be replaced once the „battery low“ symbol appears. The lock remains fully operational until the battery voltage drops below a further limit which enables operation until battery replacement. However, the internal lock functions continue until the voltage finally drops below the value required for correct operation.



1. Release centre screw on the bottom side of Input Unit (illustration A3).
2. Carefully slide out battery compartment until it catches at limit stop.
3. Remove old batteries and wait 5 minutes. Replace all 3 batteries by new ones.
Observe polarity!
4. Slide battery compartment back in and fix it with the screw. A „BEEP signal“ sounds.
5. Confirm message „BAT-CMP OPEN“ by entering Master Code or a Manager Code.
If no reaction on Master Code or Manager Code: close lock **with door open**.
If still no reaction: wait 2 minutes and enter Master Code or Manager Code again.



Warning! ***Power-out for more than 5 minutes***
If the lock is without power for more than approximately 5 minutes the internal clock will cease and reset to the last clock hour. All other settings are saved in a power-failure proof memory.
To set time and date anew the Master Code will be required!



Important! ***Disposal of used batteries***
Used batteries must be handled with caution and disposed separately.
Return used batteries to vendor. Please observe local regulations.

7.2.2 Cleaning

If necessary, clean external parts of the Input Unit with a soft, damp cloth and a mild detergent. Do **not use** solvents.

7.3 Customer Service

Should any functional errors or operating problems occur, please contact your agent or the customer service department (refer to rear cover of this manual for contact details).

7.4 Spare parts and accessories

Following items are available:

Description	P/N
Programming Software AS 254 (including cable)	AS 254
Cable RS232 for Audit Trail output	F 675
Cable for Input 3 (lock socket Q2)	on request
Operating Manual	KSW3s525.0001
Quick Reference Guide	KSW3s525.0002

INDEX

A

Access rights **EN-19**
 Accessories (available) **EN-31**
 Alarm (how to trigger) **EN-16**
 Alteration of factory settings **EN-15**
 AM/PM (how to activate/deactivate) **EN-20**
 Application (range of) **EN-3**
 Approvals and Certificates **EN-5**
 AS 254 (Programming Software) **EN-7**
 AUDIT (Menu) **EN-18**

B

Batteries (how to replace) **EN-30**
 Buzzer signals (interpretation of) **EN-11**

C

Certificates and Approvals **EN-5**
 Change code (how to) **EN-25**
 Change date (how to) **EN-20**
 Change time (how to) **EN-20**
 Checks prior installation **EN-8**
 CIT (appropriate code for) **EN-15**
 Closing lock **EN-17**
 CODE (Menu) **EN-18**
 CODE 2 (status message) **EN-12**
 Code Denial (how to program) **EN-26**
 Code entry **EN-16**
 Code structure **EN-14**
 Codes (hierarchy, formats) **EN-14**
 Codes (personalization) **EN-15**
 Commissioning **EN-10**
 CONF (status message) **EN-12**
 Confirmation Window (how to program) **EN-23**
 Connection (of lock) **EN-8**
 Connections (external) **EN-10**
 Content of package **EN-8**
 Courier Code (description) **EN-15**
 Courier Code (how to program) **EN-25**
 COVER (status message) **EN-13**

D

Date (how to set) **EN-20**
 DELAY (Menu) **EN-18**
 Delete code (how to) **EN-25**
 DENIED (status message) **EN-13**
 Display elements **EN-11**
 Display icons (description of) **EN-11**
 Display language (how to change) **EN-28**
 Diverting manoeuvre (how to employ) **EN-16**
 Dual Mode (how to enable) **EN-27**
 Duress alarm (how to trigger) **EN-16**
 Duress Code (description) **EN-16**
 Duress Code (how to enable) **EN-27**

E

Error messages **EN-29**
 Event memory (how to read-out) **EN-26**
 External connections **EN-10**

F

Factory settings **EN-6**
 Factory settings (alteration of) **EN-15**
 Faults (finding cause) **EN-29**

H

Hierarchy of codes **EN-14**
 HOLIDAY (status message) **EN-12**
 Holiday Locking Periods (how to program) **EN-22**

I

ID+PIN (code entry format) **EN-14**
 Immediate Time Lock (how to program) **EN-22**
 Information menu **EN-13**
 Input Unit (installation of) **EN-8**
 Installation (of lock) **EN-8**
 Intended purpose **EN-3**

K

Keys (description of) **EN-11**

L

Language (how to change) **EN-28**
 Lock (installation of) **EN-9**
 LOCKED (status message) **EN-12**
 Locking Periods (how to program) **EN-21**
 Lost codes **EN-15**

M

Manager Code (description) **EN-15**
 Manager Code (how to program) **EN-24**
 Master Code (description) **EN-15**
 Master Code (how to program) **EN-24**
 Menus (list of) **EN-18**
 Messages (description of) **EN-7**
 MISC (Menu) **EN-18**

O

ONLINE (status message) **EN-13**
 OPEN (status message) **EN-12**
 Opening lock **EN-17**
 Operating modes (description of) **EN-13**
 Operation elements **EN-11**
 Operation mode **EN-13**

P

Package (content) **EN-8**

PENALTY (status message) **EN-12**
Personalization of codes **EN-15**
Phantom Code (enter) **EN-16**
PIN+ID (code entry format) **EN-14**
Preparations prior installation **EN-8**
PROG (Menu) **EN-18**
Program (how to) **EN-18**
Programming Mode **EN-13**
Programming procedures **EN-20**
Programming Software AS 254 **EN-7**
Programming Time Delay (how to) **EN-23**
Purpose (intended) **EN-3**

R

Remote Disabling (how to program) **EN-26**
Replacing batteries (how to) **EN-30**
RMT-DIS (status message) **EN-12**

S

Setting time format **EN-20**
Settings (default) **EN-6**
Shelve Function (description) **EN-15**
Spare parts **EN-31**
Status messages (description of) **EN-12**
STOP ? (status message) **EN-13**
Structure of codes **EN-14**
Submenus (list of) **EN-18**
Symbols (used) **EN-7**

T

Technical data **EN-4**
Terminals (description of) **EN-10**
Text markings (used) **EN-7**
Time (how to set) **EN-20**
TIME (Menu) **EN-18**
Time Delays (how to program) **EN-23**
Time format (how to set) **EN-20**
TL LOCK (status message) **EN-12**
Troubleshooting **EN-29**

U

User Code (description) **EN-15**
User Code (how to program) **EN-24**

W

WAIT (status message) **EN-12**

Declaration of Conformity

according to 2004/108/EC and 2006/95/EC

Manufacturer: Kaba AG
Address: Mühlebühlstrasse 23
P.O. Box
CH-8620 Wetzikon, Switzerland

declares, that the product:

Product names: SL 523
SL 525
Questor

Model numbers: --

Product options: n/a

conforms to the following product specifications:

IEC 61000-6-3:	2006
CISPR 22 (Class B):	2005
EN 50130-4:	1995 / A1: 1998 / A2: 2003
EN 61000-4-2	2000
EN 61000-4-3	2006
EN 61000-4-4	2004
EN 61000-4-5	2005
EN 61000-4-6	2003 / A1: 2004 / A2: 2006

Supplementary information:

The product herewith complies with the regulations of the Low Voltage Directive 2006/95/EC and the EMC Directive 2004/108/EC.

CH-8620 Wetzikon, July 2007



Siegfried Gamma
Business Unit Manager Safe Locks



Franz Rüegg
Head of PM Safe Locks

Z1

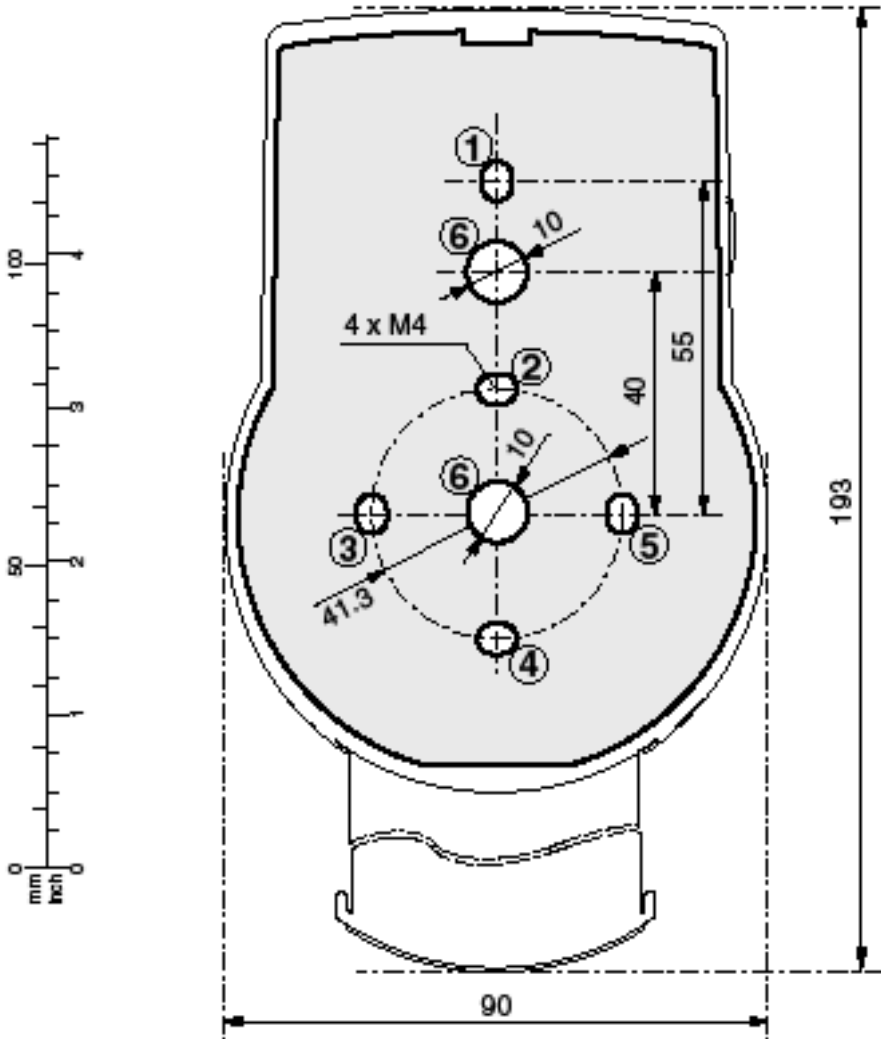

Z2

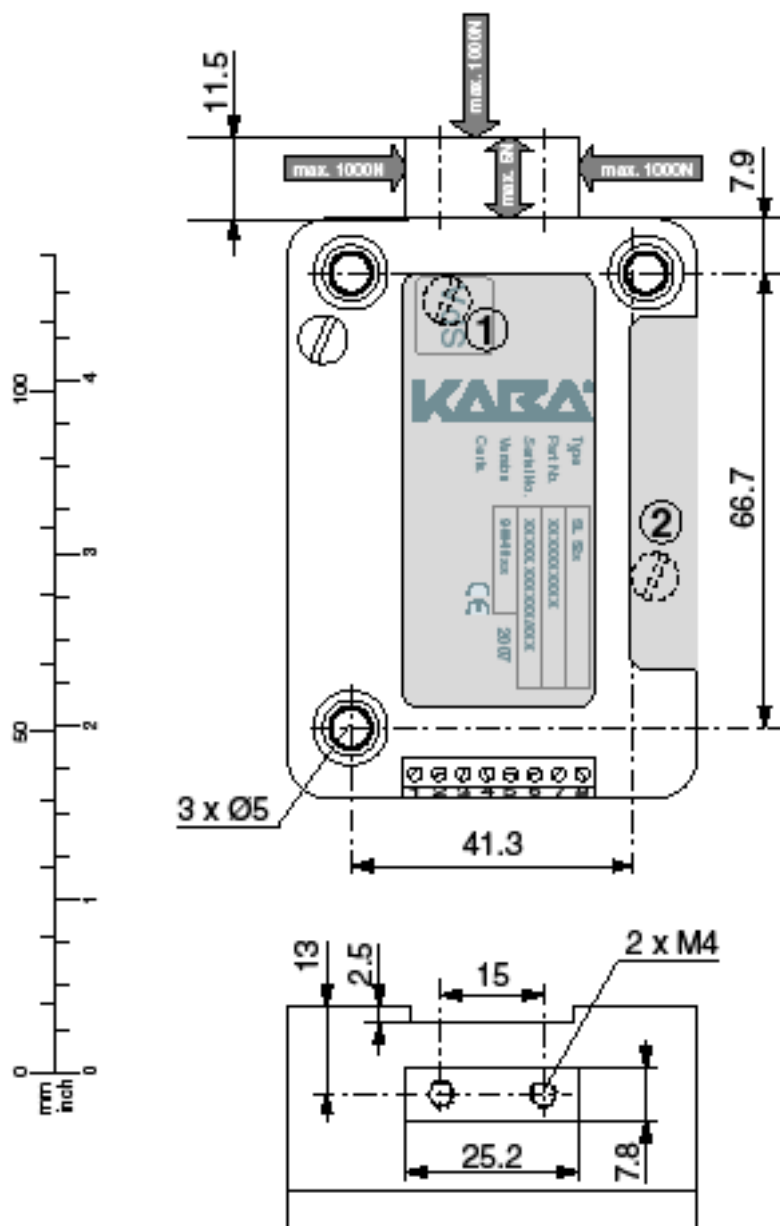

Z3



Z4



Z5

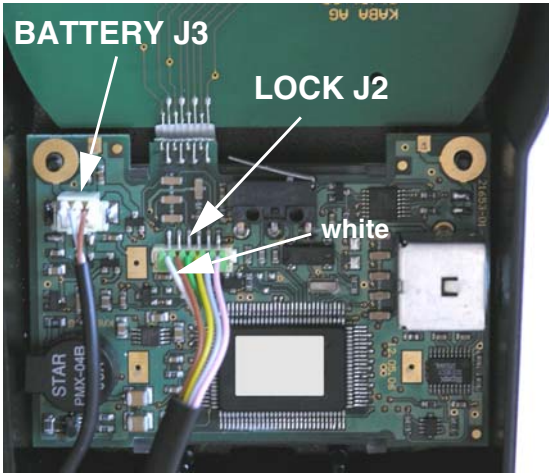

Z6a

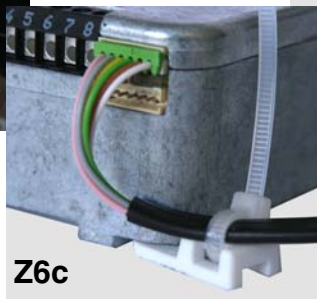

Z6c



Z6b

Z7a

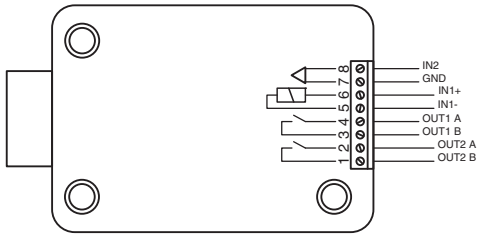

Z7b

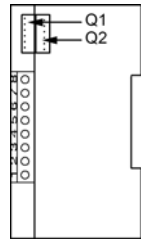

Z8



Z9

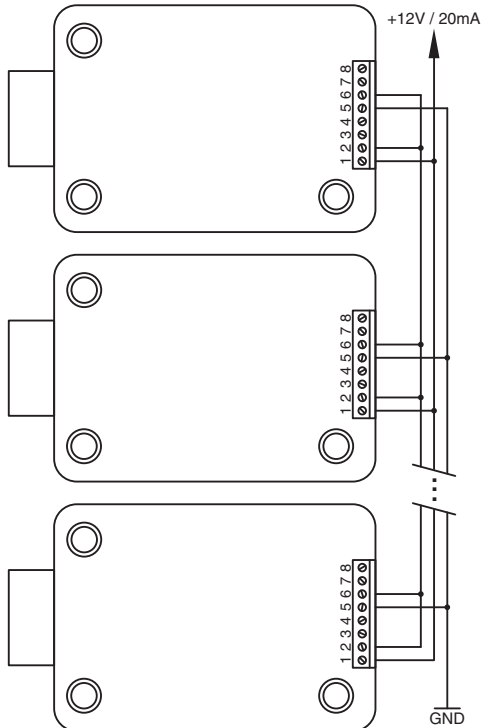



Kaba® is a registered trademark of Kaba AG.

This documentation may not be reproduced or distributed in any way – neither in digital nor in photographic form – without prior written permission of Kaba AG. © by Kaba AG, CH-8620 Wetzikon.

Document: KSW3s525.0001 / en 2009.04
Edition: April 2009